

EZ MOD EXAMPLE, 40 GAL, MODIFIED V10040

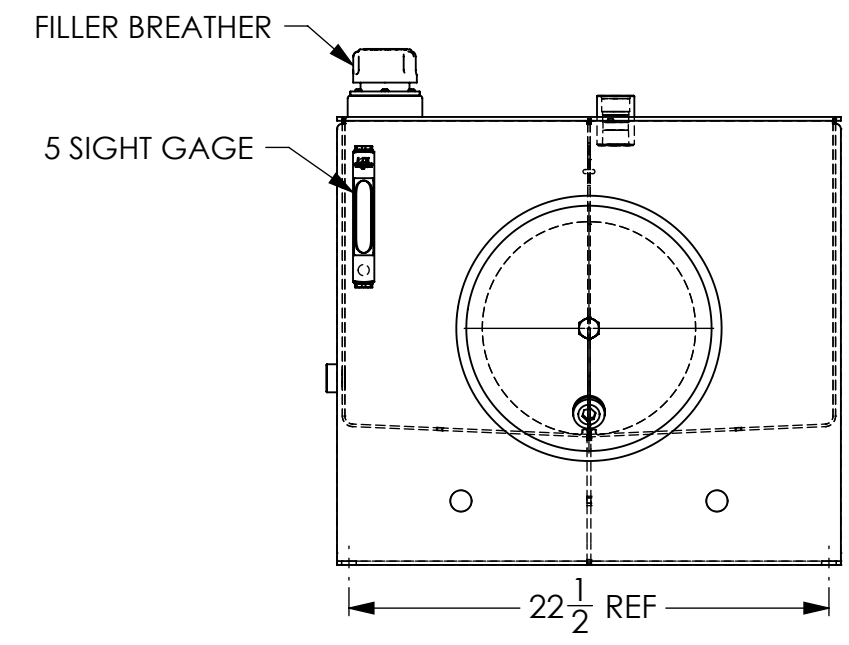
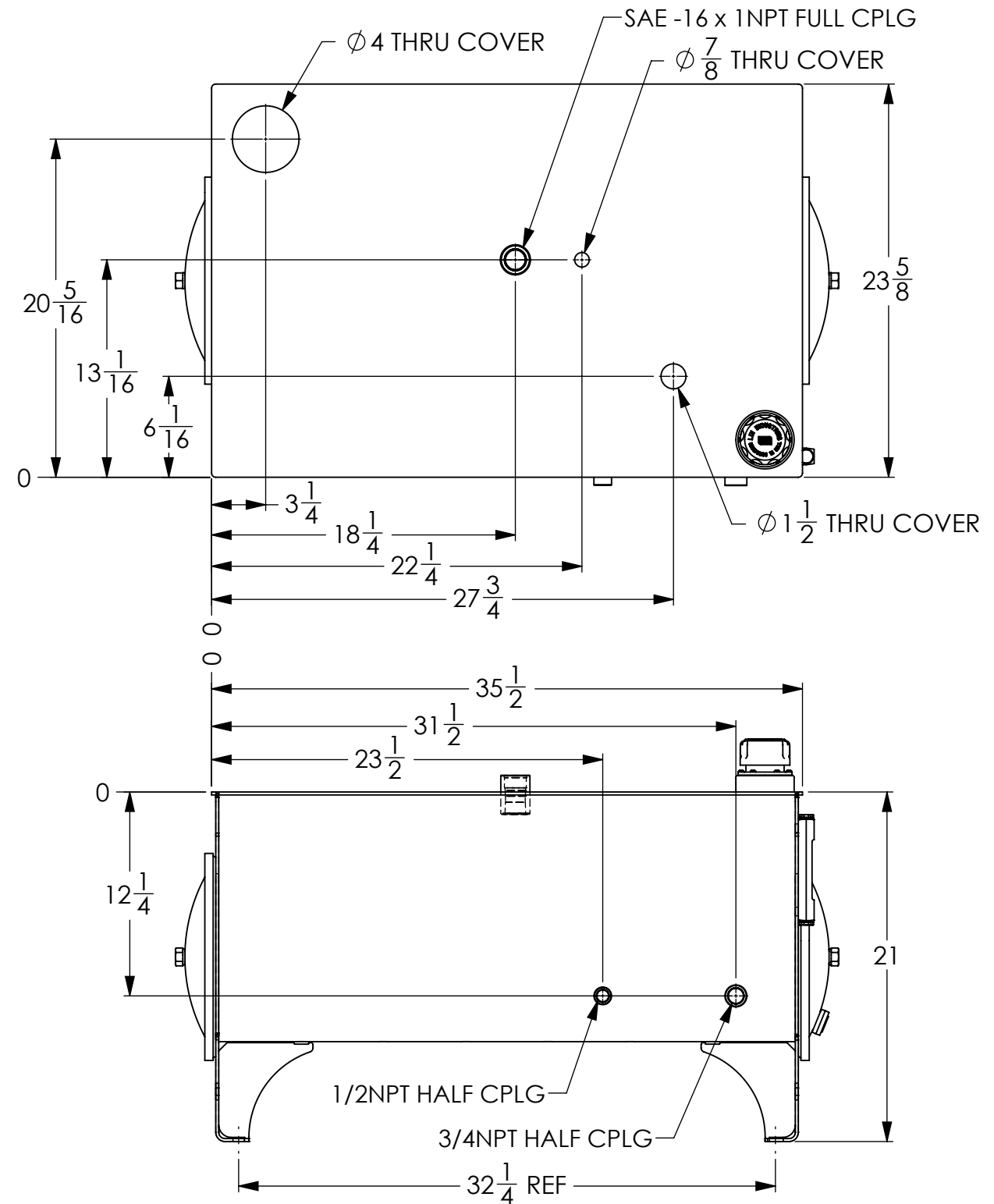
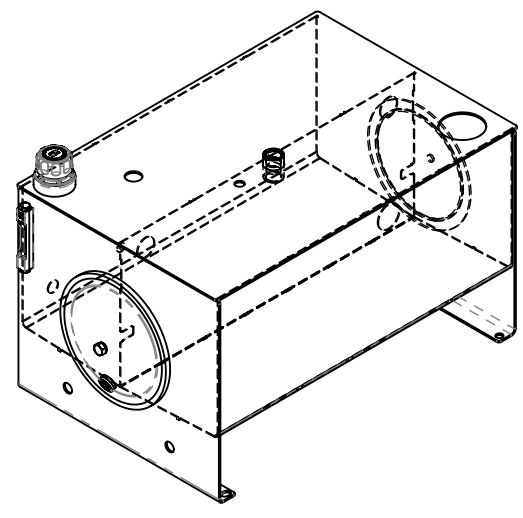

- NOTES:
1. INTERIOR OF RESERVOIR COATED WITH RUST PREVENTATIVE OIL
 2. EXTERIOR OF RESERVOIR PRIME PAINTED LDI GRAY
 3. BUNA-N SEALS

LDI Industries
 MANITOWOC, WI HUNTLEY, IL
 MATERIAL STEEL
 FINISH GRAY PRIMER
 CUST NO -

NAME	DATE	TITLE: RES_STYLE_A_40GAL_STL_PRM
DRAWN BY BMK	10/13/2020	
CHECKED BY BMK	10/13/2020	
REVISED BY DLH	10/19/2020	
THIS DOCUMENT CONTAINS INFORMATION PROPRIETARY TO LDI INDUSTRIES, INC. AND IS FURNISHED UPON THE EXPRESS CONDITION THAT THE INFORMATION CONTAINED HEREIN WILL NOT BE DISCLOSED TO ANY THIRD PARTY OR USED DIRECTLY OR INDIRECTLY IN ANY WAY DETRIMENTAL TO THE INTEREST OF LDI INDUSTRIES, INC.		ECN NO
SIZE B	DWG. NO.	REV A
DO NOT SCALE DRAWING	SCALE: 1:9	WT(LB): 182.07
		SHT 1 OF 1